

REVISIONS					
NO.	DATE	ECN #	REMARKS	BY	APPD.

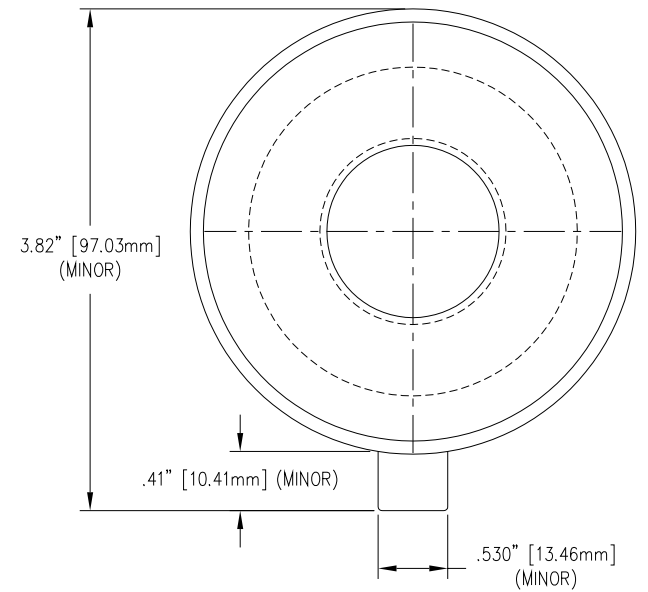
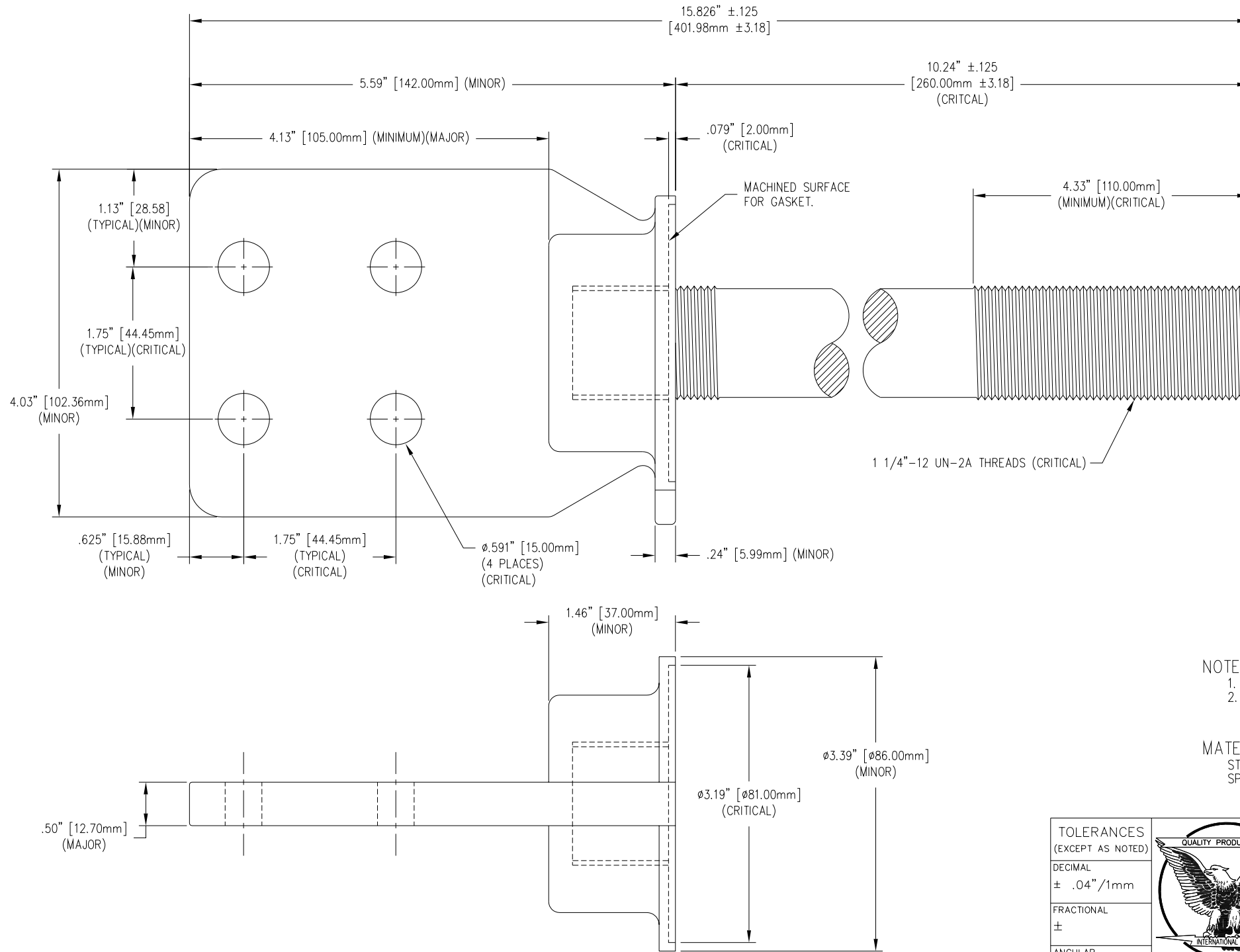

- NOTES:
1. INCLUDES THREE EXTRA BRASS NUTS.
  2. INCLUDES THREE EXTRA BRASS WASHERS.

MATERIAL:

STUD - COPPER CDA 110 (CRITICAL)

SPADE - CDA 844 TIN PLATED (CRITICAL)

TOLERANCES (EXCEPT AS NOTED) DECIMAL ± .04"/1mm FRACTIONAL ± ANGULAR ± 2°		<b>H-J ENTERPRISES, INC.</b> 3010 HIGH RIDGE BLVD. HIGH RIDGE, MO. 63049 USA PHONE 1-636-677-3421 FAX 1-636-376-1915			
		4 HOLE METRIC SPADE AND 1 1/4"-12 STUD ASSEMBLY			
		MATERIAL (SEE DRAWING)			
		CHK'D DRAWN BY CJT	APP'D DATE 3-12-01	DRAWING NO. MAS0006-003	SCALE N.T.S.